

2 0 2 4
PRODUCT
LIST

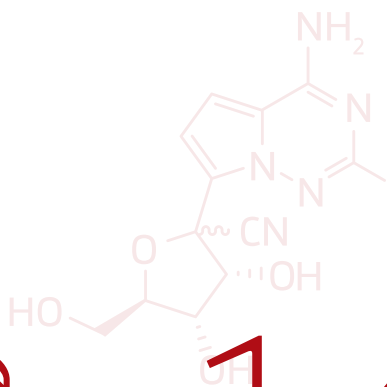

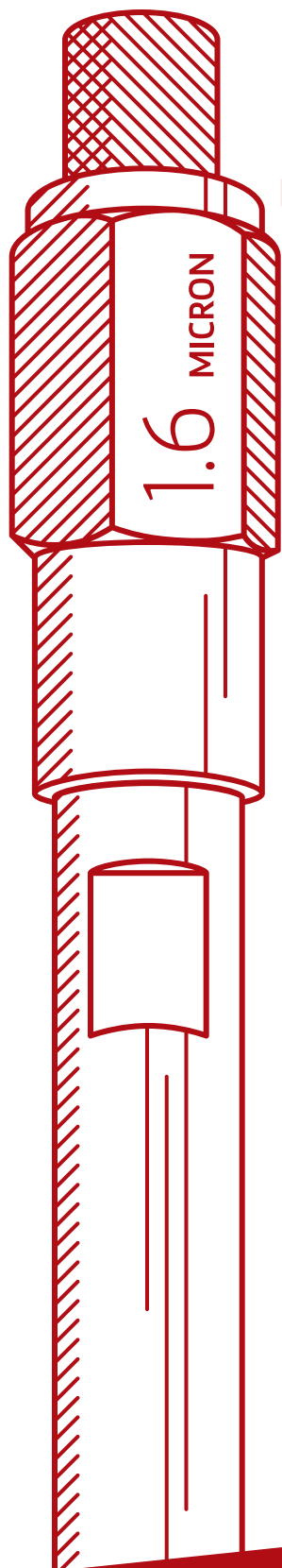

1.6 MICRON

IMMOBILIZED ANALYTICAL COLUMNS

1.6 μm 3.0 mm I.D.

Page 3

1.6 MICRON

IMMOBILIZED ANALYTICAL COLUMNS - 1.6 μ m 3.0 mm I.D.

COMPATIBLE WITH HPLC AND UHPLC (NORMAL PHASE AND REVERSED-PHASE) AND SFC

PRODUCT NAME	LENGTH (mm)	
	50	100
CHIRALPAK IA-U	80U82	80U83
CHIRALPAK IB-U	81U82	81U83
CHIRALPAK IC-U	83U82	83U83
CHIRALPAK ID-U	84U82	84U83
CHIRALPAK IG-U	87U82	87U83
CHIRALPAK IH-U	89U82	89U83

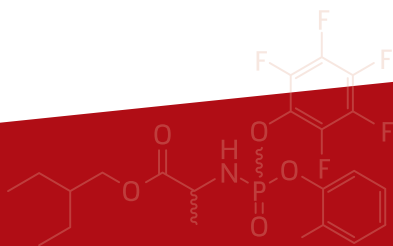
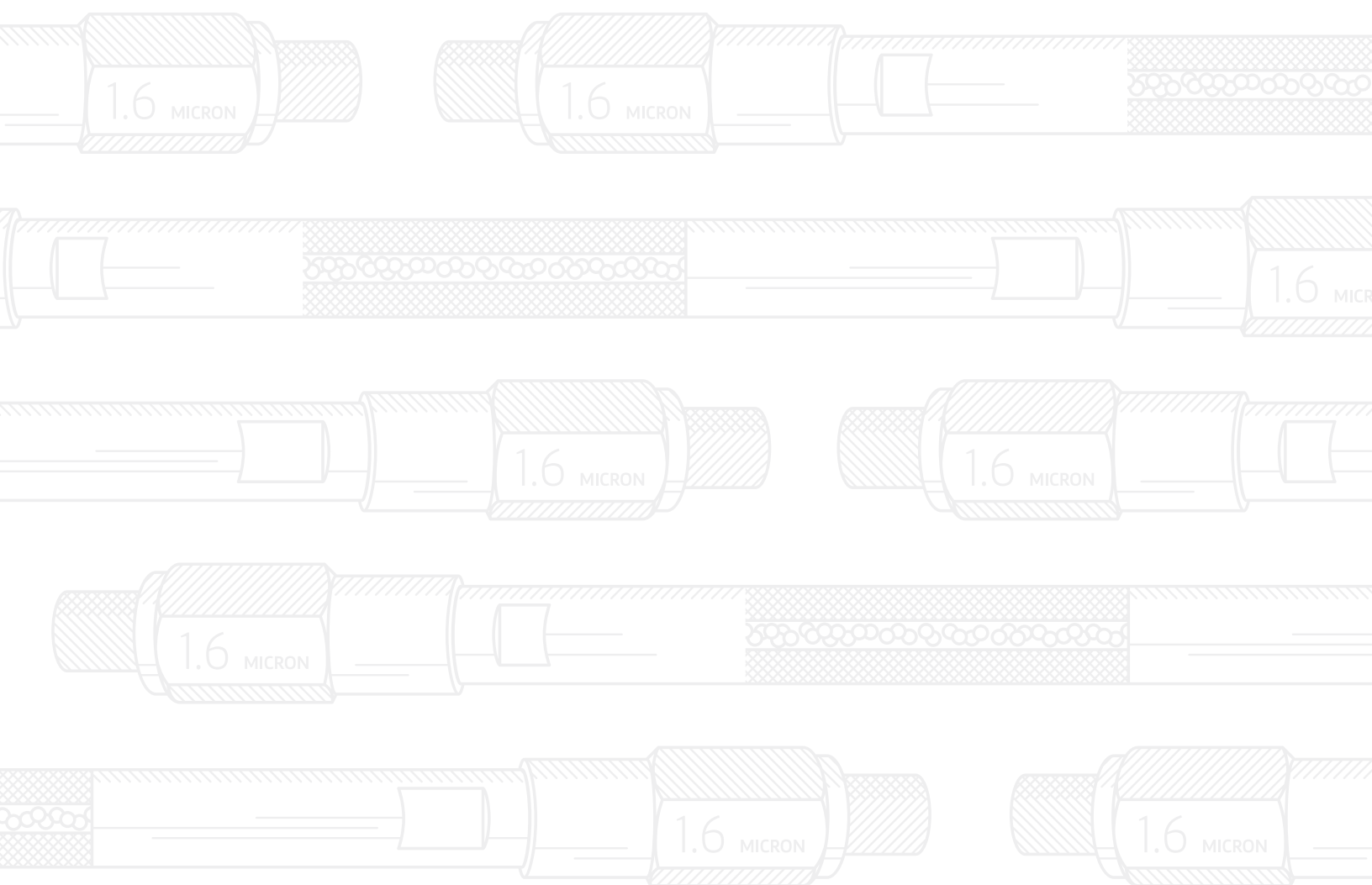

Please call us for your custom column needs.

1-800-6CHIRAL

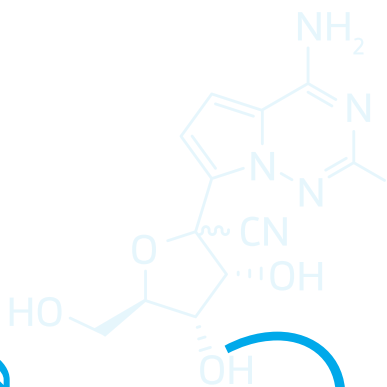
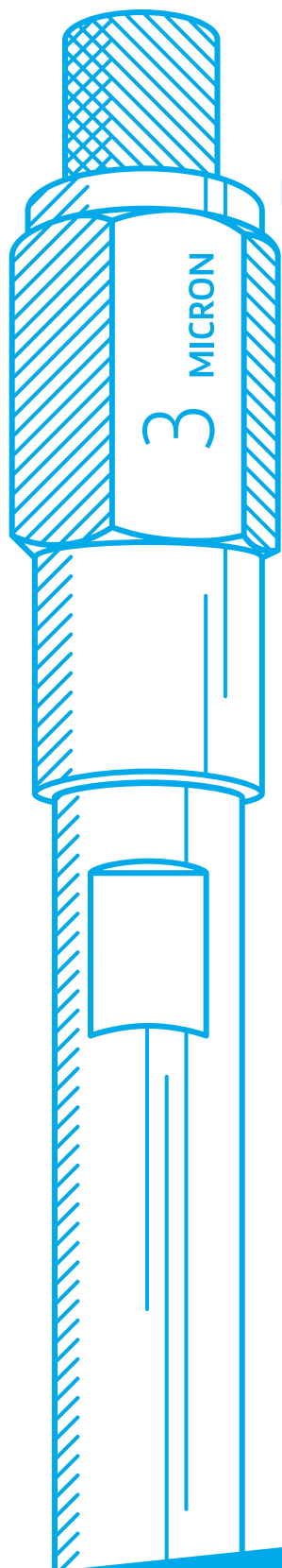

3 MICRON

IMMOBILIZED ANALYTICAL COLUMNS

3 μ m 2.1 mm I.D. Page 5

3 μ m 4.6 mm I.D. Page 6

COATED ANALYTICAL COLUMNS

3 μ m 2.1 mm I.D. Page 5

3 μ m 4.6 mm I.D. Page 6

IMMOBILIZED AND COATED ANALYTICAL COLUMNS (OPTIMIZED FOR SFC)

3 μ m 3.0 mm I.D. Page 7

3 MICRON

IMMOBILIZED ANALYTICAL COLUMNS - 3 μ m 2.1 mm I.D.

COMPATIBLE WITH HPLC AND UHPLC (NORMAL PHASE AND REVERSED-PHASE) AND SFC

PRODUCT NAME	LENGTH (mm)			
	50	100	150	250
CHIRALPAK IA-3	80592	80593	80594	80595
CHIRALPAK IB N-3	88592	88593	88594	88595
CHIRALPAK IB-3	81592	81593	81594	81595
CHIRALPAK IC-3	83592	83593	83594	83595
CHIRALPAK ID-3	84592	84593	84594	84595
CHIRALPAK IE-3	85592	85593	85594	85595
CHIRALPAK IF-3	86592	86593	86594	86595
CHIRALPAK IG-3	87592	87593	87594	87595
CHIRALPAK IH-3	89592	89593	89594	89595
CHIRALPAK IJ-3	90592	90593	90594	90595
CHIRALPAK IK-3	91592	91593	91594	91595
CHIRALPAK IM-3	92592	92593	92594	92595
CHIRALPAK IN-3	93592	93593	93594	93595

COATED ANALYTICAL COLUMNS - 3 μ m 2.1 mm I.D.

COMPATIBLE WITH HPLC AND UHPLC (NORMAL PHASE AND REVERSED-PHASE) AND SFC

PRODUCT NAME	LENGTH (mm)			
	50	100	150	250
NORMAL PHASE AND SFC				
CHIRALCEL OD-3	14592	14593	14594	14595
CHIRALCEL OJ-3	17592	17593	17594	17595
CHIRALPAK AD-3	19592	19593	19594	19595
CHIRALPAK AS-3	20592	20593	20594	20595
CHIRALCEL OZ-3	42592	42593	42594	42595
CHIRALPAK AY-3	47592	47593	47594	47595
CHIRALPAK AZ-3	61592	61593	61594	61595
CHIRALCEL OX-3	63592	63593	63594	63595
REVERSED-PHASE ONLY				
CHIRALCEL OD-3R	14892	14893	14894	14895
CHIRALCEL OJ-3R	17892	17893	17894	17895
CHIRALPAK AD-3R	19892	19893	19894	19895
CHIRALPAK AS-3R	20892	20893	20894	20895
CHIRALCEL OZ-3R	42892	42893	42894	42895
CHIRALPAK AY-3R	47892	47893	47894	47895
CHIRALPAK AZ-3R	61892	61893	61894	61895
CHIRALCEL OX-3R	63892	63893	63894	63895

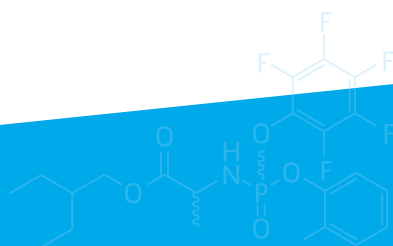

Please call us for your custom column needs.

1-800-6CHIRAL

3 MICRON

IMMOBILIZED ANALYTICAL COLUMNS - 3 μm 4.6 mm I.D.

COMPATIBLE WITH HPLC (NORMAL PHASE AND REVERSED-PHASE) AND SFC

PRODUCT NAME	LENGTH (mm)				GUARD CARTRIDGES (3)
	50	100	150	250	4.0 x 10*
CHIRALPAK IA-3	80522	80523	80524	80525	80511
CHIRALPAK IB N-3	88522	88523	88524	88525	88511
CHIRALPAK IB-3	81522	81523	81524	81525	81511
CHIRALPAK IC-3	83522	83523	83524	83525	83511
CHIRALPAK ID-3	84522	84523	84524	84525	84511
CHIRALPAK IE-3	85522	85523	85524	85525	85511
CHIRALPAK IF-3	86522	86523	86524	86525	86511
CHIRALPAK IG-3	87522	87523	87524	87525	87511
CHIRALPAK IH-3	89522	89523	89524	89525	89511
CHIRALPAK IJ-3	90522	90523	90524	90525	90511
CHIRALPAK IK-3	91522	91523	91524	91525	91511
CHIRALPAK IM-3	92522	92523	92524	92525	92511
CHIRALPAK IN-3	93522	93523	93524	93525	93511

COATED ANALYTICAL COLUMNS - 3 μm 4.6 mm I.D.

COMPATIBLE WITH HPLC (NORMAL PHASE AND REVERSED-PHASE) AND SFC

PRODUCT NAME	LENGTH (mm)				GUARD CARTRIDGES (3)
	50	100	150	250	4.0 x 10*
NORMAL PHASE AND SFC					
CHIRALCEL OD-3	14522	14523	14524	14525	14511
CHIRALCEL OJ-3	17522	17523	17524	17525	17511
CHIRALPAK AD-3	19522	19523	19524	19525	19511
CHIRALPAK AS-3	20522	20523	20524	20525	20511
CHIRALCEL OZ-3	42522	42523	42524	42525	42511
CHIRALPAK AY-3	47522	47523	47524	47525	47511
CHIRALPAK AZ-3	61522	61523	61524	61525	61511
CHIRALCEL OX-3	63522	63523	63524	63525	63511
REVERSED-PHASE ONLY					
CHIRALCEL OD-3R	14822	14823	14824	14825	14811
CHIRALCEL OJ-3R	17822	17823	17824	17825	17811
CHIRALPAK AD-3R	19822	19823	19824	19825	19811
CHIRALPAK AS-3R	20822	20823	20824	20825	20811
CHIRALCEL OZ-3R	42822	42823	42824	42825	42811
CHIRALPAK AY-3R	47822	47823	47824	47825	47811
CHIRALPAK AZ-3R	61822	61823	61824	61825	61811
CHIRALCEL OX-3R	63822	63823	63824	63825	63811

* All Guard Cartridges for analytical columns require a cartridge holder – part #00011 (pg. 29).

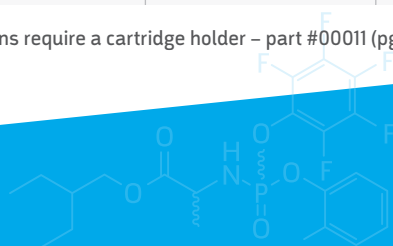

Please call us for your custom column needs.

1-800-6CHIRAL

3 MICRON OPTIMIZED FOR SFC

IMMOBILIZED ANALYTICAL COLUMNS - 3 μ m 3.0 mm I.D.

OPTIMIZED FOR SFC AND COMPATIBLE WITH UHPLC (NORMAL PHASE AND REVERSED-PHASE)

PRODUCT NAME	LENGTH (mm)		
	50	100	150
CHIRALPAK IA-3/SFC	80S82	80S83	80S84
CHIRALPAK IB N-3/SFC	88S82	88S83	88S84
CHIRALPAK IB-3/SFC	81S82	81S83	81S84
CHIRALPAK IC-3/SFC	83S82	83S83	83S84
CHIRALPAK ID-3/SFC	84S82	84S83	84S84
CHIRALPAK IE-3/SFC	85S82	85S83	85S84
CHIRALPAK IF-3/SFC	86S82	86S83	86S84
CHIRALPAK IG-3/SFC	87S82	87S83	87S84
CHIRALPAK IH-3/SFC	89S82	89S83	89S84
CHIRALPAK IJ-3/SFC	90S82	90S83	90S84
CHIRALPAK IK-3/SFC	91S82	91S83	91S84
CHIRALPAK IM-3/SFC	92S82	92S83	92S84
CHIRALPAK IN-3/SFC	93S82	93S83	93S84

COATED ANALYTICAL COLUMNS - 3 μ m 3.0 mm I.D.

OPTIMIZED FOR SFC AND COMPATIBLE WITH UHPLC (NORMAL PHASE AND REVERSED-PHASE)

PRODUCT NAME	LENGTH (mm)		
	50	100	150
CHIRALCEL OD-3/SFC	14S82	14S83	14S84
CHIRALCEL OJ-3/SFC	17S82	17S83	17S84
CHIRALPAK AD-3/SFC	19S82	19S83	19S84
CHIRALPAK AS-3/SFC	20S82	20S83	20S84
CHIRALCEL OZ-3/SFC	42S82	42S83	42S84
CHIRALPAK AY-3/SFC	47S82	47S83	47S84
CHIRALPAK AZ-3/SFC	61S82	61S83	61S84
CHIRALCEL OX-3/SFC	63S82	63S83	63S84

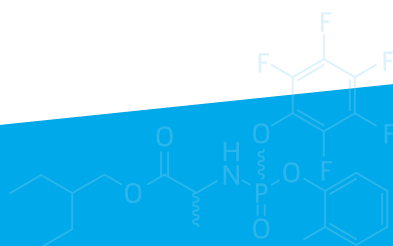
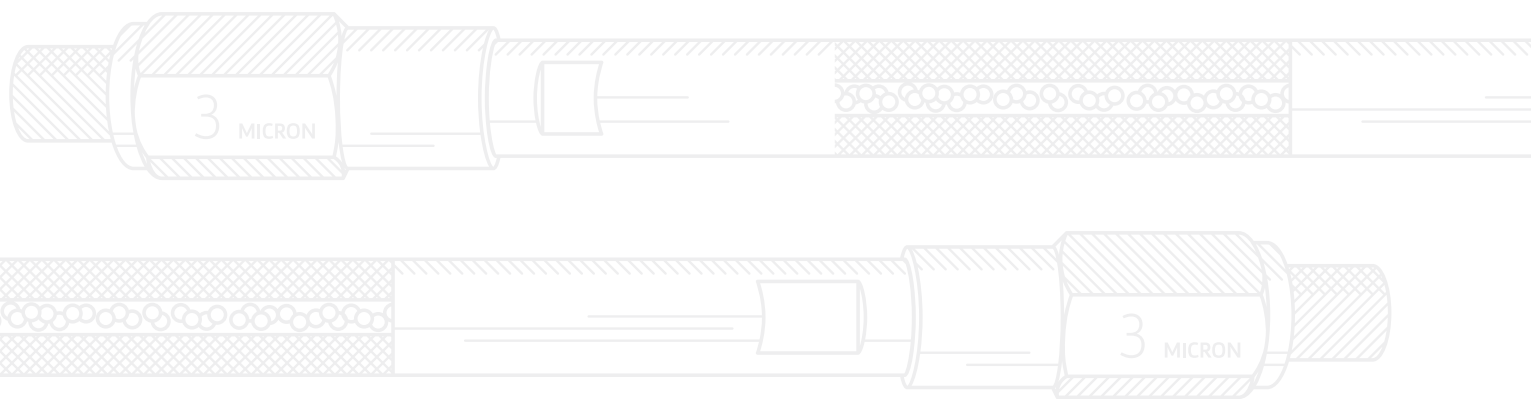

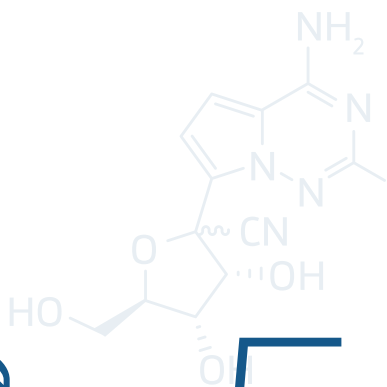
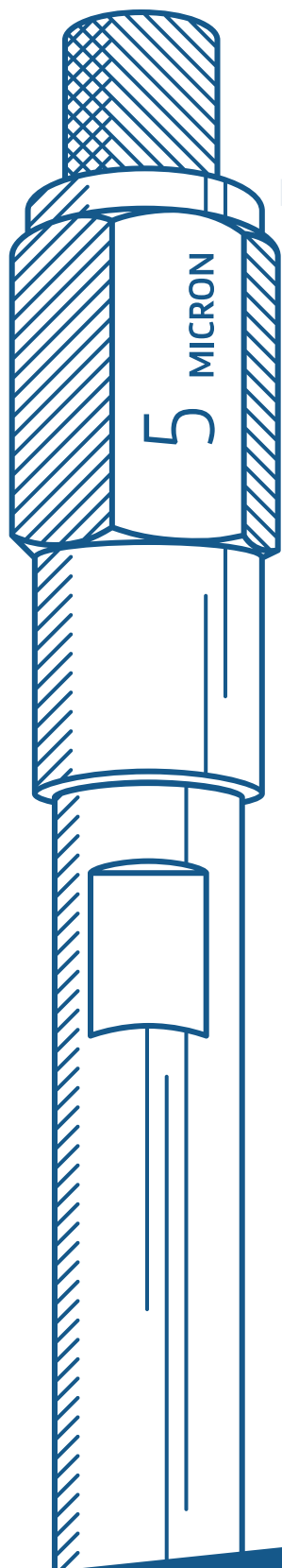

5 MICRON

IMMOBILIZED AND COATED ANALYTICAL COLUMNS

5 μ m 2.1 mm I.D. Page 9

5 μ m 4.6 mm I.D. Page 10

IMMOBILIZED SEMI-PREP AND PREP COLUMNS

5 μ m Page 11

COATED SEMI-PREP AND PREP COLUMNS

5 μ m Page 12

5 MICRON

IMMOBILIZED ANALYTICAL COLUMNS - 5 μ m 2.1 mm I.D.

COMPATIBLE WITH HPLC (NORMAL PHASE AND REVERSED-PHASE) AND SFC

PRODUCT NAME	LENGTH (mm)
	150
CHIRALPAK IA	80394
CHIRALPAK IB N-5	88394
CHIRALPAK IB	81394
CHIRALPAK IC	83394
CHIRALPAK ID	84394
CHIRALPAK IE	85394
CHIRALPAK IF	86394
CHIRALPAK IG	87394
CHIRALPAK IH	89394
CHIRALPAK IJ	90394
CHIRALPAK IK	91394
CHIRALPAK IM	92394
CHIRALPAK IN	93394

COATED ANALYTICAL COLUMNS - 5 μ m 2.1 mm I.D.

COMPATIBLE WITH HPLC (NORMAL PHASE AND REVERSED-PHASE) AND SFC

PRODUCT NAME	LENGTH (mm)
	150
NORMAL PHASE AND SFC	
CHIRALCEL OD-H	14394
CHIRALCEL OJ-H	17394
CHIRALPAK AD-H	19394
CHIRALPAK AS-H	20394
CHIRALCEL OZ-H	42394
CHIRALPAK AY-H	47394
CHIRALPAK AZ-H	61394
CHIRALCEL OX-H	63394
	150
REVERSED-PHASE ONLY	
CHIRALCEL OD-RH	14794
CHIRALCEL OJ-RH	17794
CHIRALPAK AD-RH	19794
CHIRALPAK AS-RH	20794
CHIRALCEL OZ-RH	42794
CHIRALPAK AY-RH	47794
CHIRALPAK AZ-RH	61794
CHIRALCEL OX-RH	63794

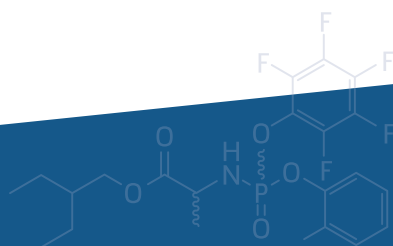
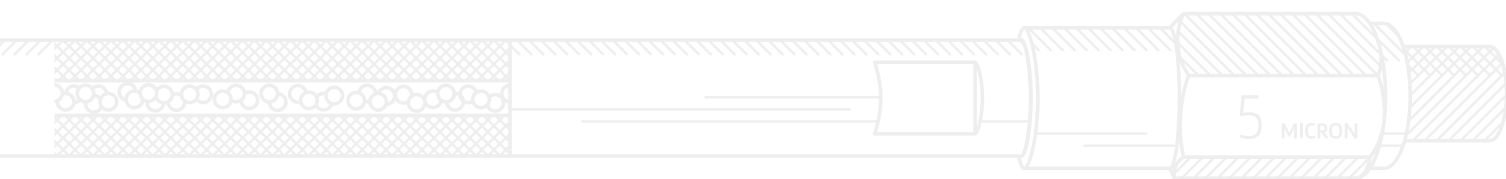

Please call us for your custom column needs.

1-800-6CHIRAL

5 MICRON

IMMOBILIZED ANALYTICAL COLUMNS - 5 μ m 4.6 mm I.D.

COMPATIBLE WITH HPLC (NORMAL PHASE AND REVERSED-PHASE) AND SFC

PRODUCT NAME	LENGTH (mm)				GUARD CARTRIDGES (3)
	50	100	150	250	4.0 x 10*
CHIRALPAK IA	80422	80423	80324	80325	80311
CHIRALPAK IB N-5	88422	88423	88324	88325	88311
CHIRALPAK IB	81422	81423	81324	81325	81311
CHIRALPAK IC	83422	83423	83324	83325	83311
CHIRALPAK ID	84422	84423	84324	84325	84311
CHIRALPAK IE	85422	85423	85324	85325	85311
CHIRALPAK IF	86422	86423	86324	86325	86311
CHIRALPAK IG	87422	87423	87324	87325	87311
CHIRALPAK IH	89422	89423	89324	89325	89311
CHIRALPAK IJ	90422	90423	90324	90325	90311
CHIRALPAK IK	91422	91423	91324	91325	91311
CHIRALPAK IM	92422	92423	92324	92325	92311
CHIRALPAK IN	93422	93423	93324	93325	93311

COATED ANALYTICAL COLUMNS - 5 μ m 4.6 mm I.D.

COMPATIBLE WITH HPLC (NORMAL PHASE AND REVERSED-PHASE) AND SFC

PRODUCT NAME	LENGTH (mm)				GUARD CARTRIDGES (3)
	50	100	150	250	4.0 x 10*
NORMAL PHASE AND/OR SFC					
CHIRALCEL OD-H	14422	14423	14324	14325	14311
CHIRALCEL OJ-H	17422	17423	17324	17325	17311
CHIRALPAK AD-H	19422	19423	19324	19325	19311
CHIRALPAK AS-H	20422	20423	20324	20325	20311
CHIRALCEL OZ-H	42422	42423	42324	42325	42311
CHIRALPAK AY-H	47422	47423	47324	47325	47311
CHIRALPAK AZ-H	61422	61423	61324	61325	61311
CHIRALCEL OX-H	63422	63423	63324	63325	63311
NORMAL PHASE ONLY					
CHIRALCEL OB-H	-	-	12324	12325	12311
CHIRALCEL OC-H	-	-	-	13325	13311

PRODUCT NAME	LENGTH (mm)	GUARD CARTRIDGES (3)
	150	4.0 x 10*
REVERSED-PHASE ONLY		
CHIRALCEL OD-RH	14724	14711
CHIRALCEL OJ-RH	17724	17711
CHIRALPAK AD-RH	19724	19711
CHIRALPAK AS-RH	20724	20711
CHIRALCEL OZ-RH	42724	42711
CHIRALPAK AY-RH	47724	47711
CHIRALPAK AZ-RH	61724	61711
CHIRALCEL OX-RH	63724	63711

* All Guard Cartridges for analytical columns require a cartridge holder – part #00011 (pg. 29).

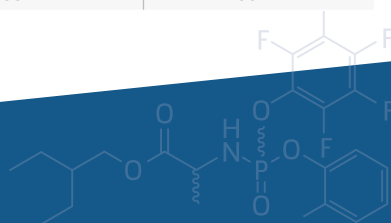

Please call us for your custom column needs.

1-800-6CHIRAL

5 MICRON

IMMOBILIZED SEMI-PREP AND PREP COLUMNS - 5 μ m

COMPATIBLE WITH HPLC (NORMAL PHASE AND REVERSED-PHASE) AND SFC

PRODUCT NAME	I.D. (mm) x LENGTH (mm)						
	10 x 250	10 x 20 Guard	20 x 250	20 x 50 Guard	30 x 250	30 x 50 Guard	50 x 250
NORMAL PHASE							
CHIRALPAK IA	80335	80337	80345	80342	80375	80372	80355
CHIRALPAK IB N-5	88335	88337	88345	88342	88375	88372	88355
CHIRALPAK IB	81335	81337	81345	81342	81375	81372	81355
CHIRALPAK IC	83335	83337	83345	83342	83375	83372	83355
CHIRALPAK ID	84335	84337	84345	84342	84375	84372	84355
CHIRALPAK IE	85335	85337	85345	85342	85375	85372	85355
CHIRALPAK IF	86335	86337	86345	86342	86375	86372	86355
CHIRALPAK IG	87335	87337	87345	87342	87375	87372	87355
CHIRALPAK IH	89335	89337	89345	89342	89375	89372	89355
CHIRALPAK IJ	90335	90337	90345	90342	90375	90372	90355
CHIRALPAK IK	91335	91337	91345	91342	91375	91372	91355
CHIRALPAK IM	92335	92337	92345	92342	92375	92372	92355
CHIRALPAK IN	93335	93337	93345	93342	93375	93372	93355
	10 x 250	10 x 50 Guard	21 x 250	21 x 50 Guard	30 x 250	30 x 50 Guard	50 x 250
SFC							
CHIRALPAK IA/SFC	80435	80432	80445	80442	80475	80472	80455
CHIRALPAK IB N-5/SFC	88435	88432	88445	88442	88475	88472	88455
CHIRALPAK IB/SFC	81435	81432	81445	81442	81475	81472	81455
CHIRALPAK IC/SFC	83435	83432	83445	83442	83475	83472	83455
CHIRALPAK ID/SFC	84435	84432	84445	84442	84475	84472	84455
CHIRALPAK IE/SFC	85435	85432	85445	85442	85475	85472	85455
CHIRALPAK IF/SFC	86435	86432	86445	86442	86475	86472	86455
CHIRALPAK IG/SFC	87435	87432	87445	87442	87475	87472	87455
CHIRALPAK IH/SFC	89435	89432	89445	89442	89475	89472	89455
CHIRALPAK IJ/SFC	90435	90432	90445	90442	90475	90472	90455
CHIRALPAK IK/SFC	91435	91432	91445	91442	91475	91472	91455
CHIRALPAK IM/SFC	92435	92432	92445	92442	92475	92472	92455
CHIRALPAK IN/SFC	93435	93432	93445	93442	93475	93472	93455

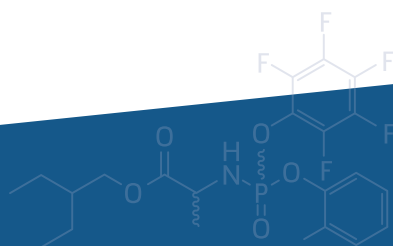
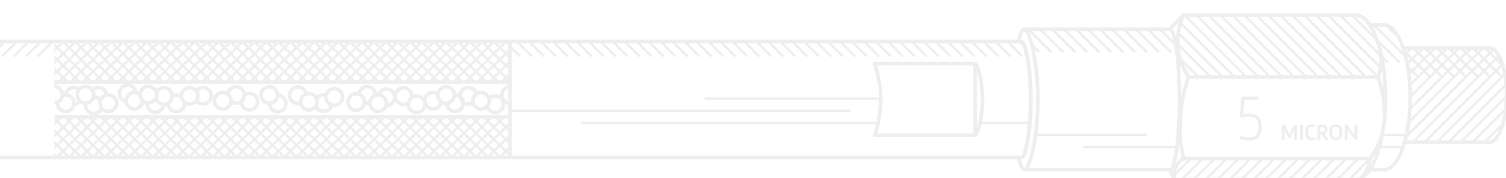

Please call us for your custom column needs.

1-800-6CHIRAL

5 MICRON

COATED SEMI-PREP AND PREP COLUMNS - 5 μ m

COMPATIBLE WITH HPLC (NORMAL PHASE AND REVERSED-PHASE) AND SFC

PRODUCT NAME	I.D. (mm) x LENGTH (mm)						
	10 x 250	10 x 20 Guard	20 x 250	20 x 50 Guard	30 x 250	30 x 50 Guard	50 x 250
NORMAL PHASE							
CHIRALCEL OD-H	14335	14337	14345	14342	14375	14372	14355
CHIRALCEL OJ-H	17335	17337	17345	17342	17375	17372	17355
CHIRALPAK AD-H	19335	19337	19345	19342	19375	19372	19355
CHIRALPAK AS-H	20335	20337	20345	20342	20375	20372	20355
CHIRALCEL OZ-H	42335	42337	42345	42342	42375	42372	42355
CHIRALPAK AY-H	47335	47337	47345	47342	47375	47372	47355
CHIRALPAK AZ-H	61335	61337	61345	61342	61375	61372	61355
CHIRALCEL OX-H	63335	63337	63345	63342	63375	63372	63355
	10 x 250	10 x 50 Guard	21 x 250	21 x 50 Guard	30 x 250	30 x 50 Guard	50 x 250
SFC							
CHIRALCEL OD-H/ SFC	14435	14432	14445	14442	14475	14472	14455
CHIRALCEL OJ-H/ SFC	17435	17432	17445	17442	17475	17472	17455
CHIRALPAK AD-H/ SFC	19435	19432	19445	19442	19475	19472	19455
CHIRALPAK AS-H/ SFC	20435	20432	20445	20442	20475	20472	20455
CHIRALCEL OZ-H/ SFC	42435	42432	42445	42442	42475	42472	42455
CHIRALPAK AY-H/ SFC	47435	47432	47445	47442	47475	47472	47455
CHIRALPAK AZ-H/ SFC	61435	61432	61445	61442	61475	61472	61455
CHIRALCEL OX-H/ SFC	63435	63432	63445	63442	63475	63472	63455
	20 x 250						
REVERSED-PHASE ONLY							
CHIRALCEL OD-RH	14745						
CHIRALCEL OJ-RH	17745						
CHIRALPAK AD-RH	19745						
CHIRALPAK AS-RH	20745						
CHIRALCEL OZ-RH	42745						
CHIRALPAK AY-RH	47745						
CHIRALPAK AZ-RH	61745						
CHIRALCEL OX-RH	63745						

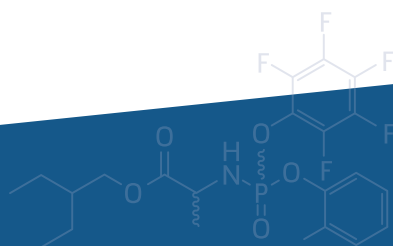
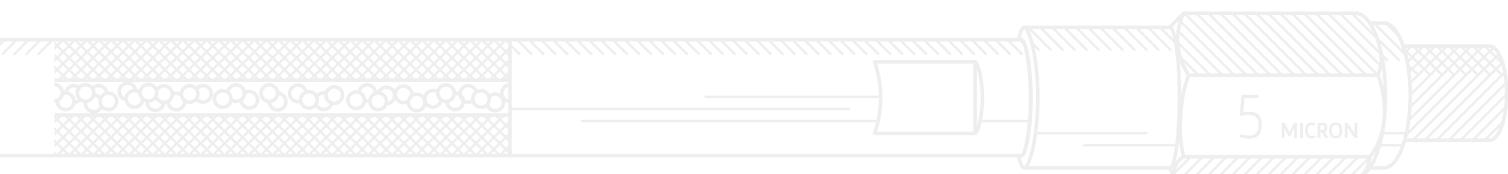
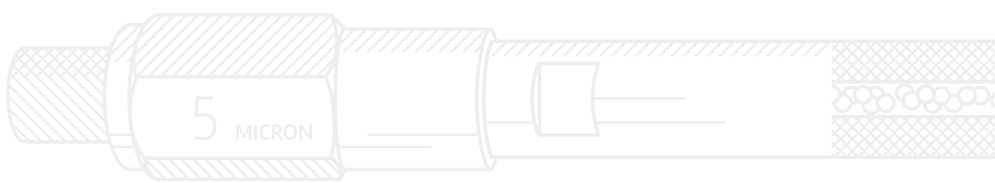

Please call us for your custom column needs.

1-800-6CHIRAL

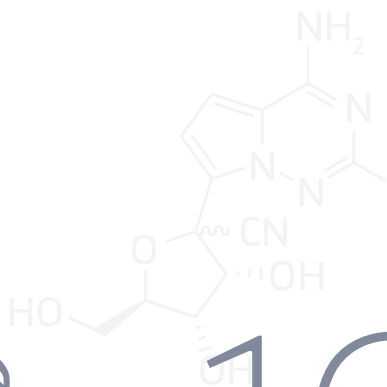
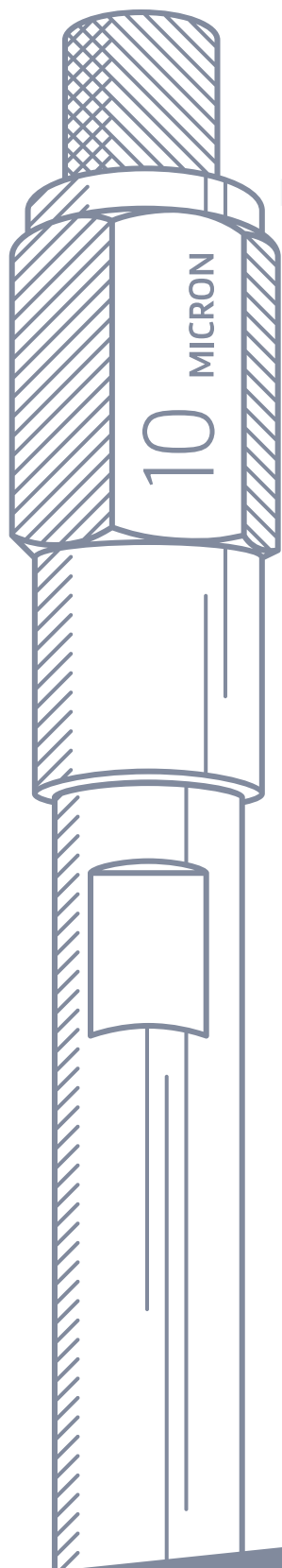

10 MICRON

IMMOBILIZED AND COATED ANALYTICAL COLUMNS

10 μm 2.1 mm I.D. Page 14

10 μm 4.6 mm I.D. Page 14

IMMOBILIZED AND COATED SEMI-PREP AND PREP COLUMNS (OPTIMIZED FOR SFC)

10 μm Page 15

COATED ANALYTICAL, SEMI-PREP AND PREP COLUMNS (OPTIMIZED FOR HPLC)

10 μm Page 16

BULK CSP

10 μm Page 17

10 MICRON

IMMOBILIZED ANALYTICAL COLUMNS - 10 µm 2.1 mm I.D. AND 4.6 mm I.D.

COMPATIBLE WITH HPLC (NORMAL PHASE AND REVERSED-PHASE) AND SFC

PRODUCT NAME	I.D. (mm) x LENGTH (mm)			
	2.1 x 150	4.6 x 50 Guard	4.6 x 150	4.6 x 250
CHIRALPAK IA-10	80♦94	80♦22	80♦24	80♦25
CHIRALPAK IB N-10	88♦94	88♦22	88♦24	88♦25
CHIRALPAK IC-10	83♦94	83♦22	83♦24	83♦25
CHIRALPAK ID-10	84♦94	84♦22	84♦24	84♦25
CHIRALPAK IE-10	85♦94	85♦22	85♦24	85♦25
CHIRALPAK IF-10	86♦94	86♦22	86♦24	86♦25
CHIRALPAK IG-10	87♦94	87♦22	87♦24	87♦25
CHIRALPAK IH-10	89♦94	89♦22	89♦24	89♦25
CHIRALPAK IJ-10	90♦94	90♦22	90♦24	90♦25
CHIRALPAK IK-10	91♦94	91♦22	91♦24	91♦25
CHIRALPAK IM-10	92♦94	92♦22	92♦24	92♦25

LEGEND

♦ = Indicate choice of:	Example:
E - Tested in Normal Phase	80E94
F - Tested in Reversed-Phase	80F94
G - Tested in SFC mode	80G94

COATED ANALYTICAL COLUMNS - 10 µm 2.1 mm I.D. AND 4.6 mm I.D.

OPTIMIZED FOR SFC

PRODUCT NAME	I.D. (mm) x LENGTH (mm)			
	2.1 x 150	4.6 x 50 Guard	4.6 x 150	4.6 x 250
CHIRALCEL OD-10/SFC	14G94	14G22	14G24	14G25
CHIRALCEL OJ-10/SFC	17G94	17G22	17G24	17G25
CHIRALPAK AD-10/SFC	19G94	19G22	19G24	19G25
CHIRALPAK AS-10/SFC	20G94	20G22	20G24	20G25
CHIRALPAK OZ-10/SFC	42G94	42G22	42G24	42G25
CHIRALPAK AY-10/SFC	47G94	47G22	47G24	47G25
CHIRALPAK AZ-10/SFC	61G94	61G22	61G24	61G25
CHIRALCEL OX-10/SFC	63G94	63G22	63G24	63G25

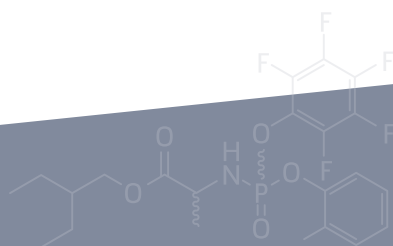

Please call us for your custom column needs.

1-800-6CHIRAL

10 MICRON OPTIMIZED FOR SFC

IMMOBILIZED SEMI-PREP AND PREP COLUMNS - 10 µm

OPTIMIZED FOR SFC

PRODUCT NAME	I.D. (mm) x LENGTH (mm)			
	10 x 250	21 x 250	30 x 250	50 x 250
CHIRALPAK IA-10/SFC	80G35	80G45	80G75	80G55
CHIRALPAK IB N-10/SFC	88G35	88G45	88G75	88G55
CHIRALPAK IC-10/SFC	83G35	83G45	83G75	83G55
CHIRALPAK ID-10/SFC	84G35	84G45	84G75	84G55
CHIRALPAK IE-10/SFC	85G35	85G45	85G75	85G55
CHIRALPAK IF-10/SFC	86G35	86G45	86G75 </td <td>86G55</td>	86G55
CHIRALPAK IG-10/SFC	87G35	87G45	87G75	87G55
CHIRALPAK IH-10/SFC	89G35	89G45	89G75	89G55
CHIRALPAK IJ-10/SFC	90G35	90G45	90G75	90G55
CHIRALPAK IK-10/SFC	91G35	91G45	91G75	91G55
CHIRALPAK IM-10/SFC	92G35	92G45	92G75	92G55

COATED SEMI-PREP AND PREP COLUMNS - 10 µm

OPTIMIZED FOR SFC

PRODUCT NAME	I.D. (mm) x LENGTH (mm)			
	10 x 250	21 x 250	30 x 250	50 x 250
CHIRALCEL OD-10/SFC	14G35	14G45	14G75	14G55
CHIRALCEL OJ-10/SFC	17G35	17G45	17G75	17G55
CHIRALPAK AD-10/SFC	19G35	19G45	19G75	19G55
CHIRALPAK AS-10/SFC	20G35	20G45	20G75	20G55
CHIRALCEL OZ-10/SFC	42G35	42G45	42G75	42G55
CHIRALPAK AY-10/SFC	47G35	47G45	47G75	47G55
CHIRALPAK AZ-10/SFC	61G35	61G45	61G75	61G55
CHIRALCEL OX-10/SFC	63G35	63G45	63G75	63G55

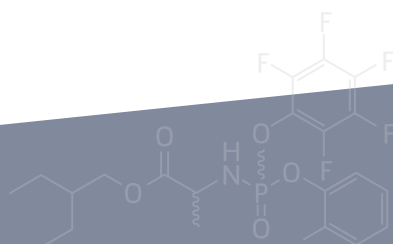
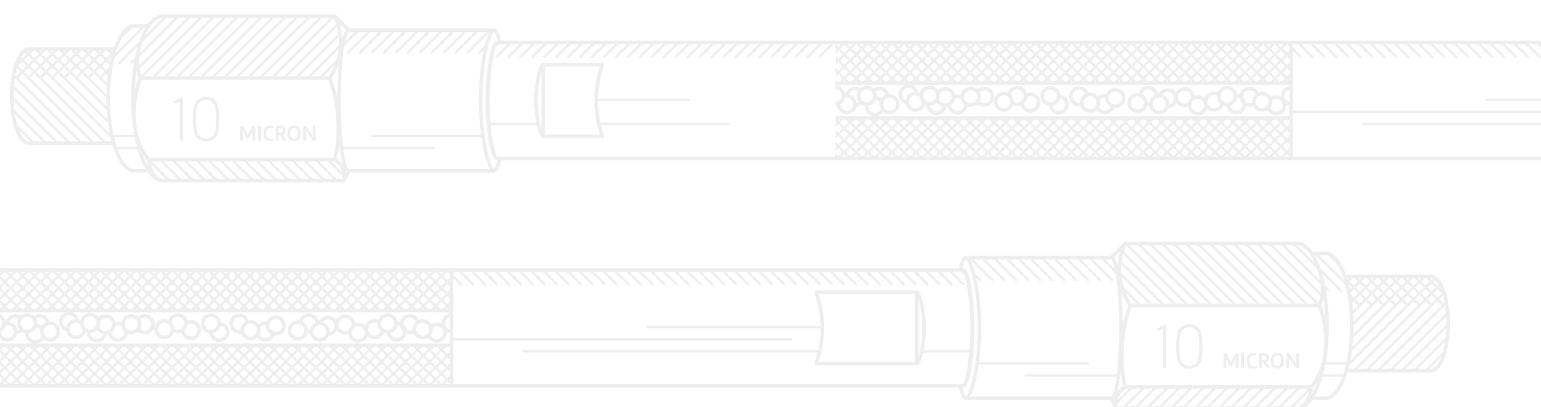

Please call us for your custom column needs.

1-800-6CHIRAL

10 MICRON OPTIMIZED FOR HPLC

COATED ANALYTICAL COLUMNS - 10 μ m 2.1 mm I.D.

OPTIMIZED FOR HPLC (NORMAL PHASE)

PRODUCT NAME	LENGTH (mm)
	150
CHIRALCEL OD	14094
CHIRALCEL OJ	17094
CHIRALPAK AD	19094
CHIRALPAK AS	20094

COATED ANALYTICAL COLUMNS - 10 μ m 4.6 mm I.D.

OPTIMIZED FOR HPLC (NORMAL PHASE AND/OR REVERSED-PHASE)

PRODUCT NAME	LENGTH (mm)		
	50 Guard	150	250
NORMAL PHASE			
CHIRALCEL OD	14022	14024	14025
CHIRALCEL OA	11022	11024	11025
CHIRALCEL OB	12022	12024	12025
CHIRALCEL OC	13022	13024	13025
CHIRALCEL OF	15022	15024	15025
CHIRALCEL OG	16022	16024	16025
CHIRALCEL OK	18022	18024	18025
NORMAL PHASE AND REVERSED-PHASE			
CHIRALCEL OJ	17022	17024	17025
CHIRALPAK AD	19022	19024	19025
CHIRALPAK AS	20022	20024	20025
CHIRALPAK AY	47022	47024	47025
CHIRALPAK AZ	61022	61024	61025
PRODUCT NAME	LENGTH (mm)	GUARD CARTRIDGES (3)	
	250	4.0 x 10*	
REVERSED-PHASE ONLY			
CHIRALCEL OD-R	14625	14611	-

COATED SEMI-PREP AND PREP COLUMNS - 10 μ m

OPTIMIZED FOR HPLC (NORMAL PHASE)

PRODUCT NAME	I.D. (mm) x LENGTH (mm)					
	10 x 50 Guard	10 x 250	20 x 50 Guard	20 x 250	30 x 50 Guard	30 x 250
CHIRALCEL OD	14032	14035	14042	14045	14072	14075
CHIRALCEL OJ	17032	17035	17042	17045	17072	17075
CHIRALPAK AD	19032	19035	19042	19045	19072	19075
CHIRALPAK AS	20032	20035	20042	20045	20072	20075
CHIRALPAK AY	47032	47035	47042	47045	47072	47075
CHIRALPAK AZ	61032	61035	61042	61045	61072	61075

* All Guard Cartridges for analytical columns require a cartridge holder – part #00011 (pg. 29).

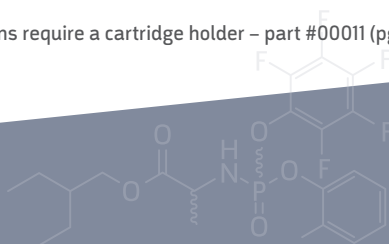

Please call us for your custom column needs.

1-800-6CHIRAL

10 MICRON

10µm BULK CSP

COMPATIBLE WITH HPLC (NORMAL PHASE AND REVERSED-PHASE) AND SFC

PRODUCT NAME	QUANTITY
	1 kg
IMMOBILIZED - NORMAL PHASE, REVERSED-PHASE AND SFC	
CHIRALPAK IA-10	8000E
CHIRALPAK IB N-10	8800E
CHIRALPAK IC-10	8300E
CHIRALPAK ID-10	8400E
CHIRALPAK IE-10	8500E
CHIRALPAK IF-10	8600E
CHIRALPAK IG-10	8700E
CHIRALPAK IH-10	8900E
CHIRALPAK IJ-10	9000E
CHIRALPAK IK-10	9100E
CHIRALPAK IM-10	9200E
COATED - NORMAL PHASE, REVERSED-PHASE AND SFC	
CHIRALCEL OD-10	1400E
CHIRALCEL OJ-10	1700E
CHIRALPAK AD-10	1900E
CHIRALPAK AS-10	2000E
CHIRALCEL OZ-10	4200E
CHIRALPAK AY-10	4700E
CHIRALPAK AZ-10	6100E
CHIRALCEL OX-10	6300E

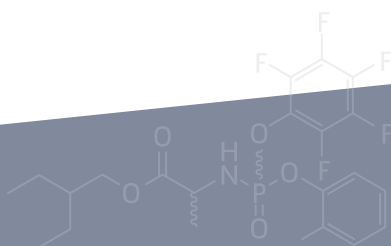
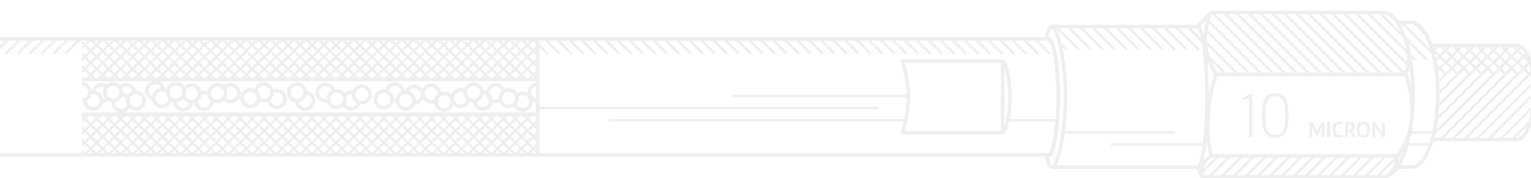

Please call us for your custom column needs.

1-800-6CHIRAL

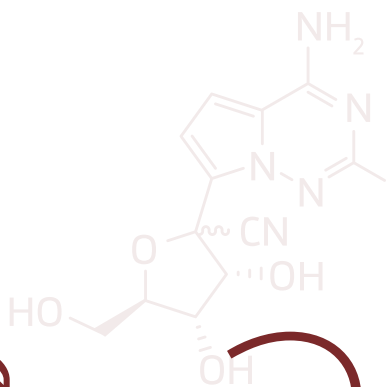
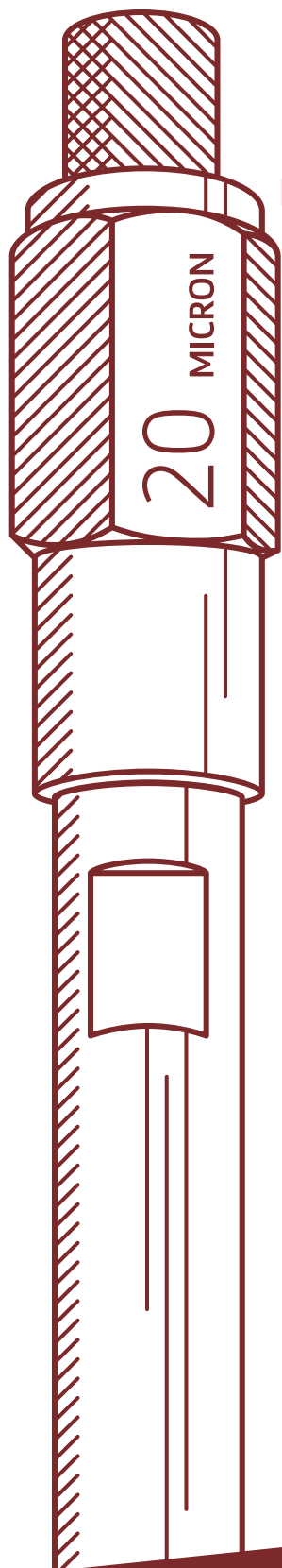

20 MICRON

IMMOBILIZED ANALYTICAL SCALE COLUMNS

20 μm 4.6 mm I.D.

Page 19

COATED ANALYTICAL SCALE COLUMNS

20 μm 4.6 mm I.D.

Page 19

IMMOBILIZED PREP COLUMNS

20 μm

Page 19

COATED PREP COLUMNS

20 μm

Page 19

BULK CSP

20 μm

Page 20

20 MICRON

IMMOBILIZED ANALYTICAL SCALE COLUMNS (FOR PREP-METHOD DEVELOPMENT) - 20 µm 4.6 mm I.D.

COMPATIBLE WITH HPLC
(NORMAL PHASE AND REVERSED-PHASE)

PRODUCT NAME	LENGTH (mm)
	250
CHIRALPAK IA	80225
CHIRALPAK IB N-20	88225
CHIRALCEL OD-I	82225
CHIRALPAK IC	83225
CHIRALPAK ID	84225
CHIRALPAK IE	85225
CHIRALPAK IF	86225
CHIRALPAK IG	87225
CHIRALPAK IH	89225
CHIRALPAK IJ	90225
CHIRALPAK IK	91225

IMMOBILIZED PREP COLUMNS - 20 µm

COMPATIBLE WITH HPLC
(NORMAL PHASE AND REVERSED-PHASE)

PRODUCT NAME	I.D. (mm) x LENGTH (mm)
	50 x 500
CHIRALPAK IA	80256
CHIRALPAK IB N-20	88256
CHIRALCEL OD-I	82256
CHIRALPAK IC	83256
CHIRALPAK ID	84256
CHIRALPAK IE	85256
CHIRALPAK IF	86256
CHIRALPAK IG	87256
CHIRALPAK IH	89256
CHIRALPAK IJ	90256
CHIRALPAK IK	91256
	100 x 500
CHIRALPAK IA	80266
CHIRALPAK IB N-20	88266
CHIRALCEL OD-I	82266
CHIRALPAK IC	83266
CHIRALPAK ID	84266
CHIRALPAK IE	85266
CHIRALPAK IF	86266
CHIRALPAK IG	87266
CHIRALPAK IH	89266
CHIRALPAK IJ	90266
CHIRALPAK IK	91266

COATED ANALYTICAL SCALE COLUMNS (FOR PREP-METHOD DEVELOPMENT) - 20 µm 4.6 mm I.D.

COMPATIBLE WITH HPLC
(NORMAL PHASE)

PRODUCT NAME	LENGTH (mm)
	250
CHIRALCEL OD	14225
CHIRALCEL OJ	17225
CHIRALPAK AD	19225
CHIRALPAK AS	20225
CHIRALCEL OZ	42225
CHIRALPAK AY	47225
CHIRALPAK AZ	61225
CHIRALCEL OX	63225

COATED PREP COLUMNS - 20 µm

COMPATIBLE WITH HPLC
(NORMAL PHASE)

PRODUCT NAME	I.D. (mm) x LENGTH (mm)
	50 x 500
CHIRALCEL OD	14256
CHIRALCEL OJ	17256
CHIRALPAK AD	19256
CHIRALPAK AS	20256
CHIRALCEL OZ	42256
CHIRALPAK AY	47256
CHIRALPAK AZ	61256
CHIRALCEL OX	63256
	100 x 500
CHIRALCEL OD	14266
CHIRALCEL OJ	17266
CHIRALPAK AD	19266
CHIRALPAK AS	20266
CHIRALCEL OZ	42266
CHIRALPAK AY	47266
CHIRALPAK AZ	61266
CHIRALCEL OX	63266

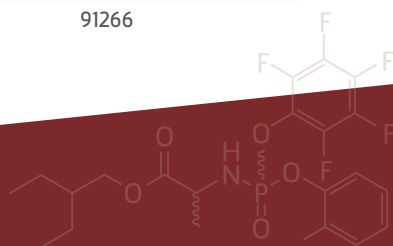

Please call us for your custom column needs.

1-800-6CHIRAL

20 MICRON

20 μ m BULK CSP

COMPATIBLE WITH HPLC (NORMAL PHASE AND REVERSED-PHASE)

PRODUCT NAME	QUANTITY	
	1 kg	100 g
IMMOBILIZED - NORMAL PHASE AND REVERSED-PHASE		
CHIRALPAK IA	80020	80021
CHIRALPAK IB N-20	88020	88021
CHIRALCEL OD-I	82020	82021
CHIRALPAK IC	83020	83021
CHIRALPAK ID	84020	84021
CHIRALPAK IE	85020	85021
CHIRALPAK IF	86020	86021
CHIRALPAK IG	87020	87021
CHIRALPAK IH	89020	89021
CHIRALPAK IJ	90020	90021
CHIRALPAK IK	91020	91021
COATED - NORMAL PHASE AND REVERSED-PHASE		
CHIRALCEL OD	14020	14021
CHIRALCEL OJ	17020	17021
CHIRALPAK AD	19020	19021
CHIRALPAK AS	20020	20021
CHIRALCEL OZ	42020	42021
CHIRALPAK AY	47020	47021
CHIRALPAK AZ	61020	61021
CHIRALCEL OX	63020	63021

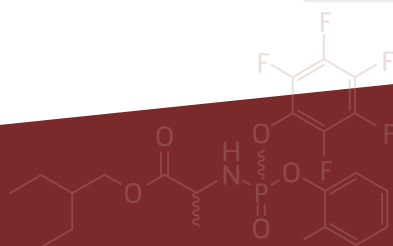
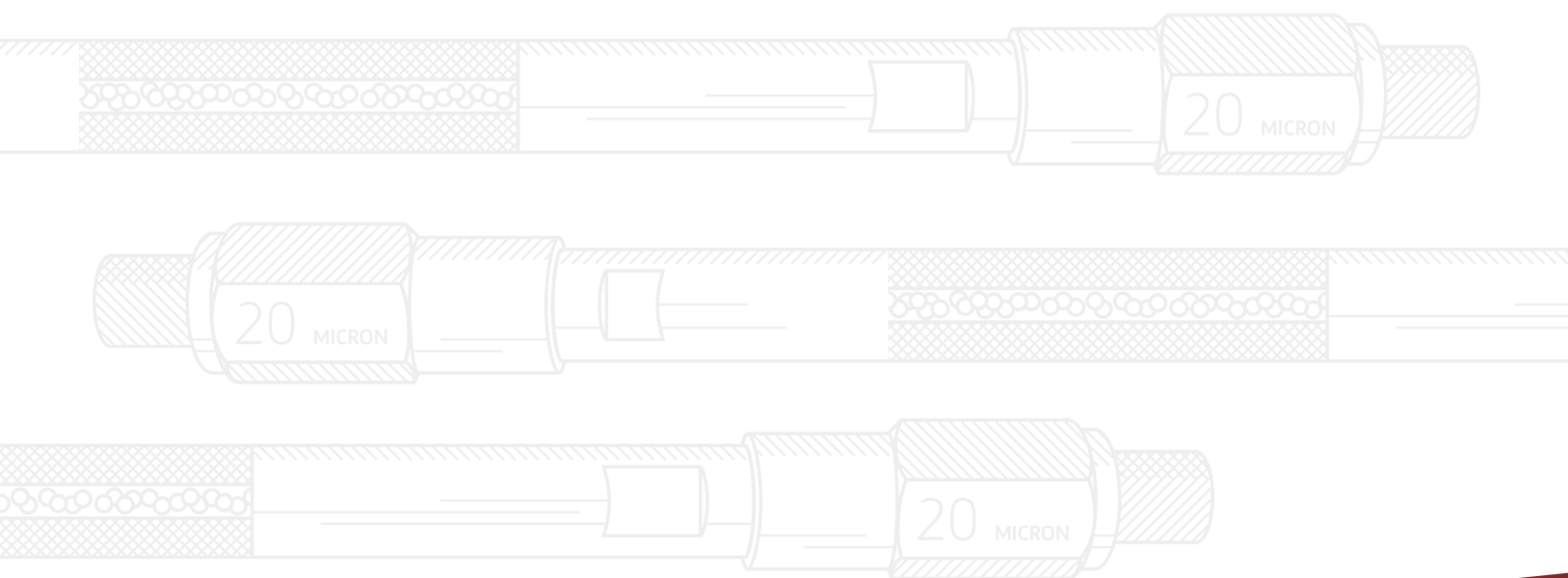

Please call us for your custom column needs.

1-800-6CHIRAL

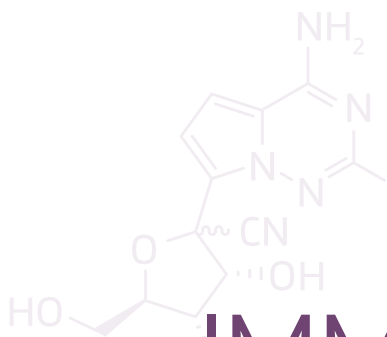
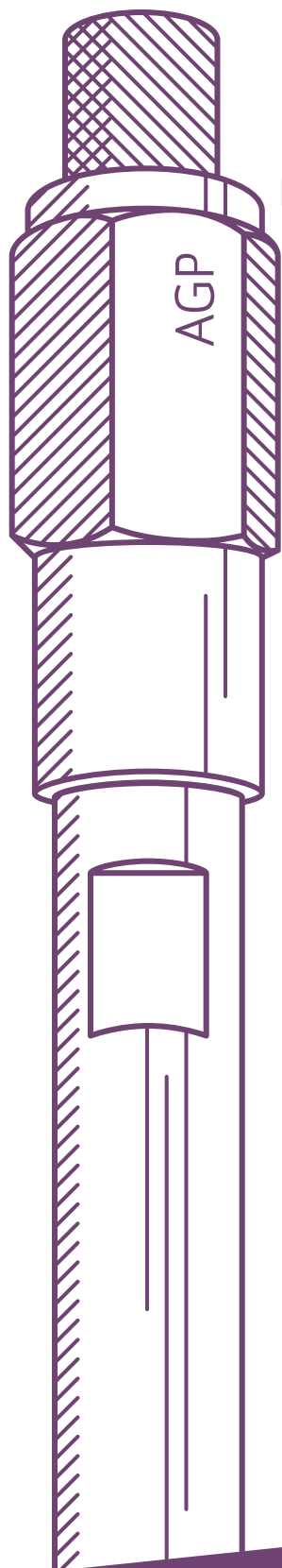

IMMOBILIZED PROTEIN-BASED COLUMNS

IMMOBILIZED PROTEIN-BASED COLUMNS

5 μ m 2.1 mm I.D. Page 22

5 μ m 3.0 mm I.D. Page 22

5 μ m 4.0 mm I.D. Page 22

IMMOBILIZED PROTEIN-BASED SEMI-PREP COLUMNS

5 μ m Page 23

Column Accessories Page 23

IMMOBILIZED PROTEIN-BASED COLUMNS

IMMOBILIZED PROTEIN-BASED COLUMNS - 5 μ m 2.1 mm I.D

COMPATIBLE WITH HPLC (REVERSED-PHASE)

PRODUCT NAME	LENGTH (mm)			GUARD CARTRIDGES (2)
	50	100	150	2.0 x 10*
CHIRALPAK AGP	30792	30793	30794	30791
CHIRALPAK CBH	33792	33793	33794	33791
CHIRALPAK HSA	34792	34793	34794	34791
CHIRALPAK BSA	35792	-	-	-
CHIRALPAK DSA	36792	-	-	-
CHIRALPAK RSA	38792	-	-	-

IMMOBILIZED PROTEIN-BASED COLUMNS - 5 μ m 3.0 mm I.D

COMPATIBLE WITH HPLC (REVERSED-PHASE)

PRODUCT NAME	LENGTH (mm)			GUARD CARTRIDGES (2)
	50	100	150	3.0 x 10*
CHIRALPAK AGP	30782	30783	30784	30781
CHIRALPAK CBH	33782	33783	33784	33781
CHIRALPAK HSA	34782	34783	34784	34781
CHIRALPAK BSA	35782	-	-	-
CHIRALPAK DSA	36782	-	-	-
CHIRALPAK MSA	37782	-	-	-
CHIRALPAK RSA	38782	-	-	-
CHIRALPAK PSA	43782	-	-	-

IMMOBILIZED PROTEIN-BASED COLUMNS - 5 μ m 4.0 mm I.D

COMPATIBLE WITH HPLC (REVERSED-PHASE)

PRODUCT NAME	LENGTH (mm)			GUARD CARTRIDGES (2)
	50	100	150	4.0 x 10*
CHIRALPAK AGP	30712	30713	30714	30711
CHIRALPAK CBH	33712	33713	33714	33711
CHIRALPAK HSA	34712	34713	34714	34711
CHIRALPAK BSA	35712	-	35714	-
CHIRALPAK DSA	36712	-	36714	-
CHIRALPAK MSA	37712	-	-	-
CHIRALPAK RSA	38712	-	38714	-
CHIRALPAK PSA	43712	-	-	-

* All Guard Cartridges for Immobilized Protein-Based Columns require a cartridge holder - part #00081 (pg. 23).

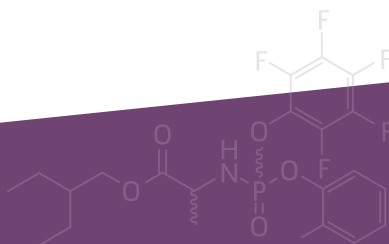

Please call us for your custom column needs.

1-800-6CHIRAL

IMMOBILIZED PROTEIN-BASED COLUMNS

IMMOBILIZED PROTEIN-BASED COLUMNS - SEMI-PREP COLUMNS - 5 μ m

COMPATIBLE WITH HPLC (REVERSED-PHASE)

PRODUCT NAME	I.D. (mm) x LENGTH (mm)	
	10 x 100	10 x 150
CHIRALPAK AGP	30733	30734
CHIRALPAK CBH	33733	33734
CHIRALPAK HSA	34733	34734

IMMOBILIZED PROTEIN-BASED COLUMN ACCESSORIES

PRODUCT NAME	
GUARD CARTRIDGE HOLDER	00081
GUARD COLUMN COUPLER	000D1
GUARD COLUMN MICRO-COUPLER	000D2

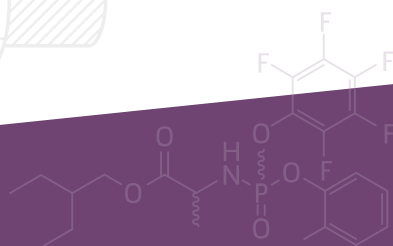

Please call us for your custom column needs.

1-800-6CHIRAL

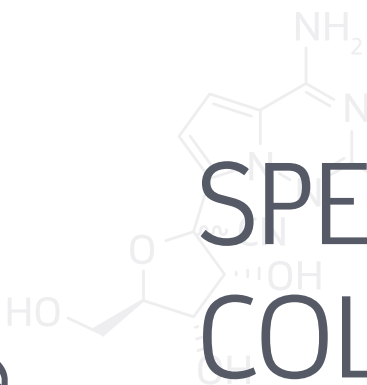
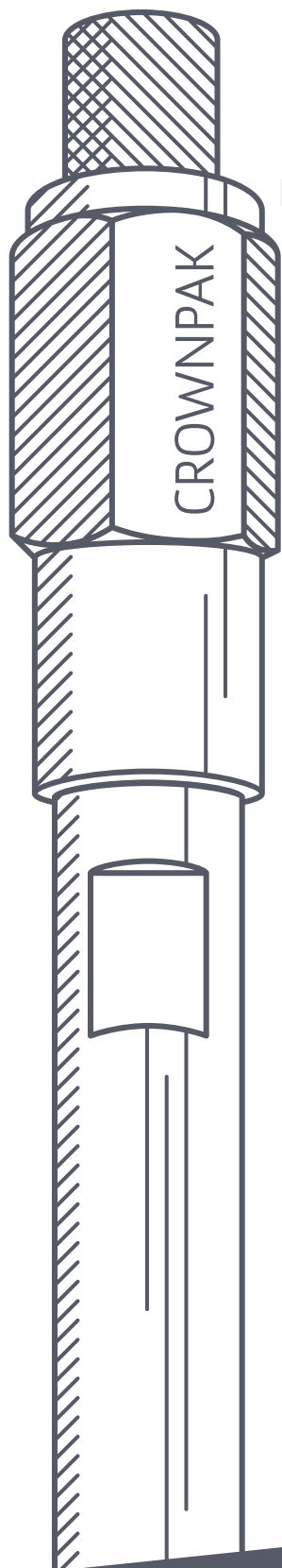

SPECIALTY COLUMNS

ZWITTERIONIC COLUMNS

3 μm Page 25

5 μm Page 25

ANION EXCHANGE COLUMNS

5 μm Page 25

IMMOBILIZED CROWN ETHER COLUMNS

5 μm Page 26

COATED CROWN ETHER COLUMNS

5 μm Page 26

LIGAND EXCHANGE COLUMNS Page 26

IMMOBILIZED MPLC COLUMNS

20 μm Page 26

IMMOBILIZED CHIRAL TLC PLATES

20 μm Page 26

SPECIALTY COLUMNS

ZWITTERIONIC COLUMNS - ANALYTICAL - 3 μ m

COMPATIBLE WITH HPLC (POLAR ORGANIC PHASE AND HYDRO-ORGANIC PHASE) AND SFC

PRODUCT NAME	I.D. (mm) x LENGTH (mm)			
	3.0 x 150	3.0 x 250	4.0 x 150	4.0 x 250
CHIRALPAK ZWIX(+)	51584	51585	51514	51515
CHIRALPAK ZWIX(-)	52584	52585	52514	52515

ZWITTERIONIC COLUMNS - SEMI-PREP - 5 μ m

COMPATIBLE WITH HPLC (POLAR ORGANIC PHASE AND HYDRO-ORGANIC PHASE) AND SFC

PRODUCT NAME	I.D. (mm) x LENGTH (mm)			
	10 x 150	10 x 250	21 x 150	21 x 250
CHIRALPAK ZWIX(+)	51334	51335	51344	51345
CHIRALPAK ZWIX(-)	52334	52335	52344	52345

ANION EXCHANGE COLUMNS - 5 μ m

COMPATIBLE WITH HPLC (POLAR ORGANIC PHASE AND HYDRO-ORGANIC PHASE) AND SFC

PRODUCT NAME	I.D. (mm) x LENGTH (mm)				
	ANALYTICAL		GUARD CARTRIDGES (3)	HPLC SEMI-PREP	SFC SEMI-PREP
	2.1 x 150	4.6 x 150	4.0 x 10*	21 x 150	21 x 150
CHIRALPAK QD-AX	31394	31324	31311	31344	31444
CHIRALPAK QN-AX	32394	32324	32311	32344	32444

* All Guard Cartridges for analytical columns require a cartridge holder – part #00011 (pg. 29).

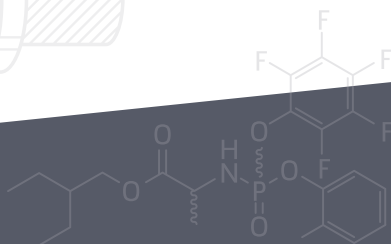
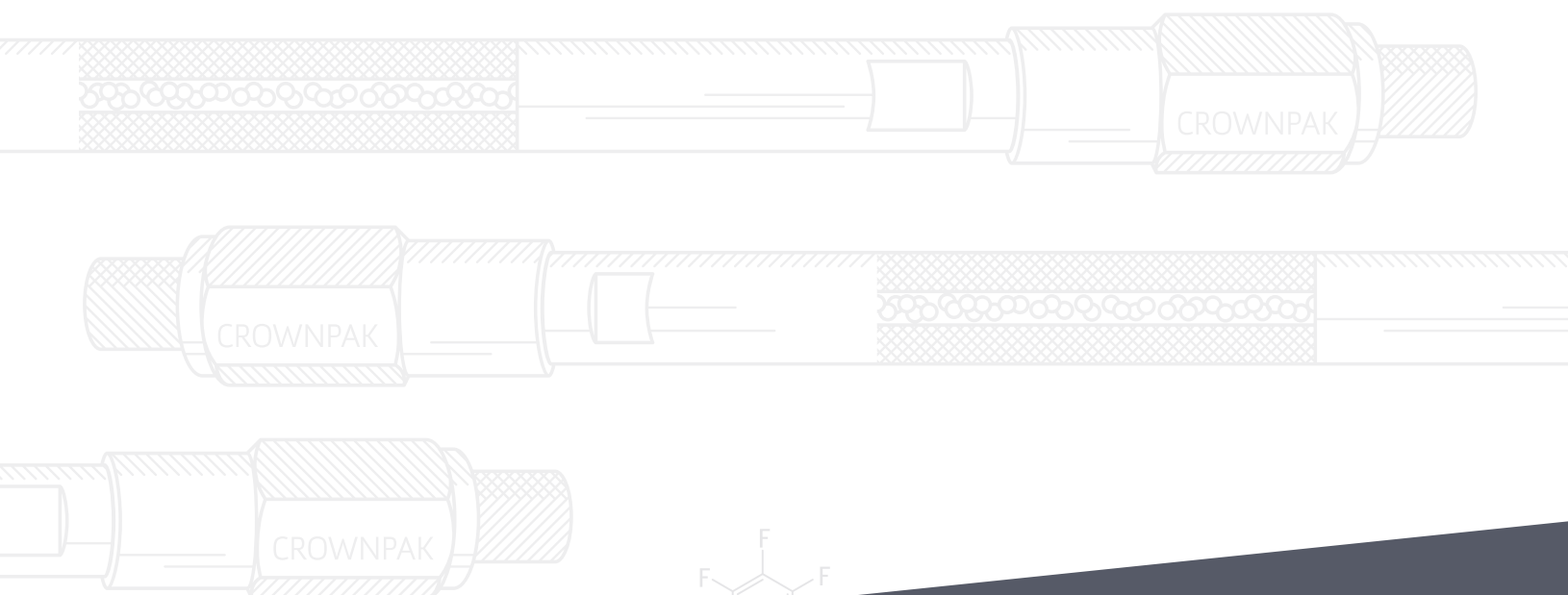

Please call us for your custom column needs.

1-800-6CHIRAL

SPECIALTY COLUMNS

IMMOBILIZED CROWN ETHER COLUMNS - 5 μ m

COMPATIBLE WITH HPLC (NORMAL PHASE AND REVERSED-PHASE)

PRODUCT NAME	I.D. (mm) x LENGTH (mm)
	ANALYTICAL
	3.0 x 150
CROWNPAK CR-I(+)	53784
CROWNPAK CR-I(-)	54784

COATED CROWN ETHER COLUMNS - 5 μ m

COMPATIBLE WITH HPLC (REVERSED-PHASE)

PRODUCT NAME	I.D. (mm) x LENGTH (mm)	
	ANALYTICAL	GUARD COLUMN
	4.0 x 150	4.0 x 10
CROWNPAK CR	-	27711
CROWNPAK CR(+)	27714	-
CROWNPAK CR(-)	28714	-

LIGAND EXCHANGE COLUMNS - ANALYTICAL

COMPATIBLE WITH HPLC (REVERSED-PHASE)

PRODUCT NAME	I.D. (mm)	PARTICLE SIZE (μ m)	LENGTH (mm)
CHIRALPAK MA(+)	21822	3	50
CHIRALPAK WH GUARD	25622	10	50
CHIRALPAK WH	25625	10	250

IMMOBILIZED MPLC COLUMNS METHOD DEVELOPMENT - 20 μ m

PRODUCT NAME	I.D. (mm) x LENGTH (mm)
	4.6 x 100
CHIRALPAK IA	80223
CHIRALPAK IC	83223
CHIRALPAK ID	84223
CHIRALPAK IE	85223
CHIRALPAK IF	86223
CHIRALPAK IG	87223

IMMOBILIZED MPLC COLUMNS SEMI-PREP - 20 μ m

PRODUCT NAME	I.D. (mm) x LENGTH (mm)
	30 x 100
CHIRALFLASH IA	80M73
CHIRALFLASH IC	83M73
CHIRALFLASH ID	84M73
CHIRALFLASH IE	85M73
CHIRALFLASH IF	86M73
CHIRALFLASH IG	87M73

IMMOBILIZED CHIRAL TLC PLATES METHOD DEVELOPMENT - 20 μ m

PRODUCT NAME	I.D. (mm) x LENGTH (mm)
	200 x 100
2L-ChiralTLC 5 (5-pkg/1 each)	5ST5A
2L-ChiralTLC IA (2-pkg)	80T2A
2L-ChiralTLC IC (2-pkg)	83T2A
2L-ChiralTLC ID (2-pkg)	84T2A
2L-ChiralTLC IE (2-pkg)	85T2A
2L-ChiralTLC IF (2-pkg)	86T2A

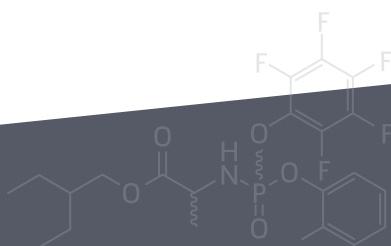

Please call us for your custom column needs.

1-800-6CHIRAL

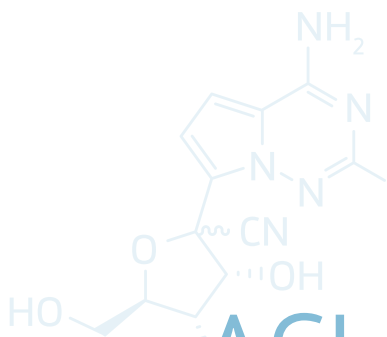
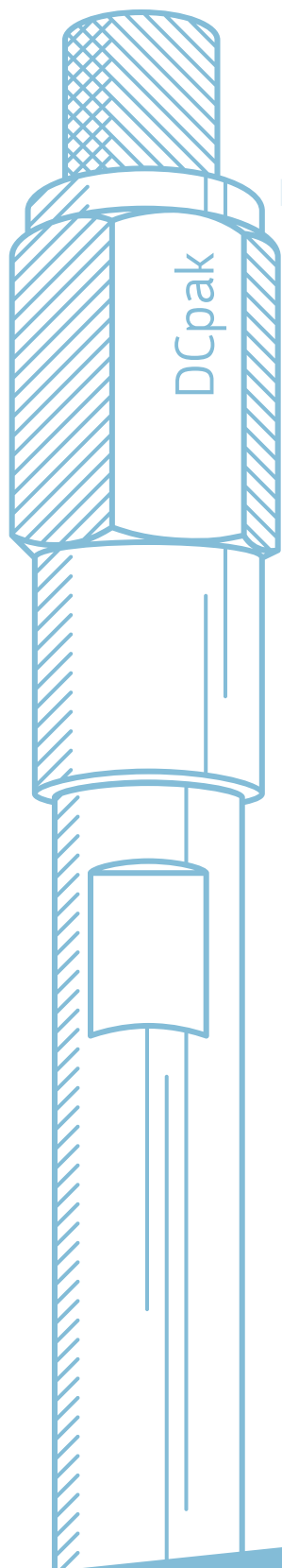

ACHIRAL COLUMNS

ANALYTICAL COLUMNS

3 μm Page 28

5 μm Page 28

SEMI-PREP AND PREP COLUMNS

5 μm Page 28

ACHIRAL COLUMNS

ACHIRAL COLUMNS - ANALYTICAL - 3 μm

COMPATIBLE WITH HPLC (NORMAL PHASE AND REVERSED-PHASE) AND SFC

PRODUCT NAME	I.D. (mm) x LENGTH (mm)			
	2.1 x 50	2.1 x 100	2.1 x 150	
DCpak PBT	AAS92	AAS93	AAS94	
DCpak P4VP	ABS92	ABS93	ABS94	
DCpak PTZ	AC592	AC593	AC594	
DCpak PMPC	AD592	AD593	AD594	
	3.0 x 50	3.0 x 100	3.0 x 150	
DCpak PBT	AAS82	AAS83	AAS84	
DCpak P4VP	ABS82	ABS83	ABS84	
DCpak PTZ	AC582	AC583	AC584	
DCpak PMPC	AD582	AD583	AD584	

PRODUCT NAME	I.D. (mm) x LENGTH (mm)				GUARD CARTRIDGES (3) Recommended for LC use only
	4.6 x 50	4.6 x 100	4.6 x 150	4.6 x 250	4.0 x 10*
DCpak PBT	AAS22	AAS23	AAS24	AAS25	AA511
DCpak P4VP	ABS22	ABS23	ABS24	ABS25	AB511
DCpak PTZ	AC522	AC523	AC524	AC525	AC511
DCpak PMPC	AD522	AD523	AD524	AD525	AD511

ACHIRAL COLUMNS - ANALYTICAL - 5 μm

COMPATIBLE WITH HPLC (NORMAL PHASE AND REVERSED-PHASE) AND SFC

PRODUCT NAME	I.D. (mm) x LENGTH (mm)				GUARD CARTRIDGES (3) Recommended for LC use only
	2.1 x 150	2.1 x 250	4.6 x 150	4.6 x 250	4.0 x 10*
DCpak PBT	AA494	AA495	AA424	AA425	AA311
DCpak P4VP	AB494	AB495	AB424	AB425	AB311
DCpak PTZ	AC394	AC395	AC324	AC325	AC311
DCpak PMPC	AD394	AD395	AD324	AD325	AD311

ACHIRAL COLUMNS - SEMI-PREP AND PREP - 5 μm

COMPATIBLE WITH HPLC (NORMAL PHASE AND REVERSED-PHASE) AND SFC

PRODUCT NAME	I.D. (mm) x LENGTH (mm)			
	10 x 250	20 x 250	30 x 250	50 x 250
DCpak PBT	AA435	AA445	AA475	AA455
DCpak P4VP	AB435	AB445	AB475	AB455
DCpak PTZ	AC335	AC345	AC375	AC355
DCpak PMPC	AD335	AD345	AD375	AD355

* All Guard Cartridges for analytical columns require a cartridge holder – part #00011 (pg. 29).

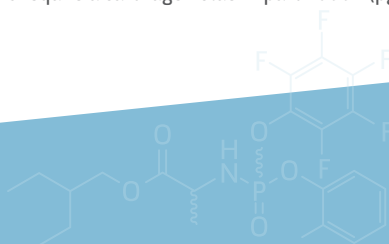

Please call us for your custom column needs.

1-800-6CHIRAL

COLUMN ACCESSORIES

COLUMN ACCESSORIES

PRODUCT NAME	PRODUCT TYPE	PART NUMBER	I.D. (mm)	LENGTH (mm)
Cartridge Holder	Holder	00011	4.0	10
Column Jacket, 15 cm	Jacket	00024	4.6	150
Column Jacket, 25 cm	Jacket	00025	4.6	250
Pre Column Filter Assembly	Holder and Filter	00060	21.2	-
Pre Column Filter, 2 micron	Replacement Filter	00061	21.2	-
Assembly O-Rings	Replacement O-Rings, set of 2	00062	-	-
Guard Filter Kit (1 holder, 3 glass filters, 2 fittings and 1 tubing)	Holder, Filters (3), Fittings (2) and Tubing	FK002	-	-
Replacement Guard Filters	Guard Filters (6)	FR002	-	-

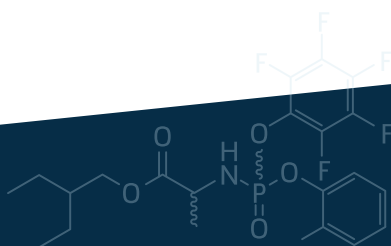

Please call us for your custom column needs.

1-800-6CHIRAL

CHIRAL TECHNOLOGIES, INC.
STANDARD TERMS AND CONDITIONS OF
SALE (EFFECTIVE APRIL 1, 2002 - revised 4/2023)

The following terms and conditions (the "Terms and Conditions") apply to all sales of chiral chromatography products (collectively, the "Products") by Chiral Technologies, Inc. ("CHIRAL") to its customers (each, a "CUSTOMER"). References to a "Party" or to the "Parties" herein shall mean either CHIRAL or CUSTOMER or each of them together. Each of the Parties agrees that it is entering into this agreement for the purpose of purchasing or selling, as the case may be, the Products, which the CUSTOMER shall only use for research purposes and not in connection with any other medical, clinical or other use. By ordering or accepting any Products from CHIRAL, CUSTOMER agrees to the foregoing and to be legally bound as follows:

SECTION 1. FORMATION OF THE CONTRACT. An agreement between the Parties, if made and entered into by way of a purchase order and an acceptance thereof, shall be deemed to have been made and entered into when CUSTOMER has issued a written purchase order and CHIRAL has accepted said purchase order. Any alteration and/or supplement to any purchase order shall be valid only if such alteration and/or supplement is accepted by CHIRAL.

SECTION 2. QUOTATIONS. Unless otherwise specified in a written statement signed by CHIRAL, no price quote by CHIRAL shall be binding. Any binding price quote given by CHIRAL shall be effective for thirty (30) days, unless otherwise specified in a written statement signed by CHIRAL.

SECTION 3. TERMS OF PAYMENT. CHIRAL will invoice CUSTOMER for Products upon shipment. All payments owed by CUSTOMER to CHIRAL, including, without limitation, payment for the purchase price of Products purchased, applicable taxes and cancellation charges, are payable in U.S. Dollars and will be due thirty (30) days after the invoice date of the Products. Interest shall accrue at the rate of ten percent (10%) per annum on the amount due commencing thirty (30) days after the invoice date; provided that, in the event that such interest rate violates applicable usury laws, such rate shall be reduced to the highest rate (if any) allowed by such laws.

SECTION 4. DELIVERY OF PRODUCTS; CANCELLATION AND DELAYED ORDERS. CHIRAL and CUSTOMER shall agree on a mutually convenient delivery schedule for Products. All Products shall be shipped F.O.B. CHIRAL's facility. Unless documented elsewhere, title of the product transfers to the buyer upon shipment. Title and invoicing for direct shipments to customers by CHIRAL's overseas affiliates will occur upon receipt of the product by the customer. CHIRAL reserves the right to ship Products prior to the agreed shipment date in order to accommodate CHIRAL's overall delivery schedules. CUSTOMER shall have no right to cancel any purchase order or to reschedule any scheduled delivery of Products covered by a purchase order, except with CHIRAL's written permission.

SECTION 5. INSPECTION. Upon receipt of Products, CUSTOMER shall promptly inspect such Products. If upon such inspection, CUSTOMER finds any Products to be defective, CUSTOMER shall promptly provide CHIRAL with written notification of such condition.

SECTION 6. TRADEMARKS. CUSTOMER shall not remove from the Products (or their packaging or documentation), or alter, any of CHIRAL's trademarks, trade names, logos, patent or copyright notices, or other notices or markings, or add any other notices or markings to the Products, without the prior express written consent of CHIRAL.

SECTION 7. LIMITED WARRANTY.

A. WARRANTY TERMS. Subject to the provisions of this Section 7 and Section 8 below, with respect to each Product sold by CHIRAL hereunder, CHIRAL warrants that for a period of one

(1) year from the date of sale (the "Warranty Period") such product will be free from defects in materials or faulty workmanship and shall comply with quality specifications for such Product published by CHIRAL. The warranties provided by CHIRAL in this Section 7.A are the only warranties provided by CHIRAL with respect to the Products sold hereunder, and may be modified or amended only by a written instrument signed by CHIRAL and accepted by CUSTOMER.

B. WARRANTY CLAIMS. If, during the applicable Warranty Period for a Product sold by CHIRAL hereunder, it is determined that Product does not conform to the limited warranty set forth in Section 7.A, then CUSTOMER shall notify CHIRAL of such condition and request authorization to return the Product to exercise the CUSTOMER'S warranty rights. CUSTOMER may, after obtaining a return authorization number and shipping instructions from CHIRAL, return such Product to CHIRAL. Upon receipt of any such Product during the applicable Warranty Period, CHIRAL shall, at its option and expense (1) repair or replace such Product, and ship such Product to the location from which it was returned to CHIRAL, or (2) give CUSTOMER a credit for such Product. All replaced Products or Products returned to CHIRAL for credit shall become CHIRAL'S property. Repair or replacement of a Product does not extend the Warranty Period for such Product.

C. OTHER LIMITATIONS. THE EXPRESS LIMITED WARRANTIES OF CHIRAL STATED IN SECTION 7.A ABOVE DO NOT APPLY TO (1) PROTEIN-BASED PRODUCTS (2) PRODUCTS USED FOR MEDICAL, CLINICAL OR ANY OTHER USE OTHER THAN RESEARCH USE, (3) PRODUCTS WHICH HAVE BEEN IMPROPERLY TRANSPORTED, INSTALLED OR USED, ALTERED, MODIFIED, REPAIRED OR SERVICED IN ANY RESPECT, EXCEPT BY CHIRAL OR ITS REPRESENTATIVES, (4) PRODUCTS WHERE SERIAL NUMBERS HAVE BEEN REMOVED OR ALTERED, (5) PRODUCTS USED BY ANY PERSON OR ENTITY OTHER THAN CUSTOMER, OR (6) PRODUCTS THE INVOICE FOR WHICH HAS NOT BEEN PAID IN FULL IN ACCORDANCE WITH THE PAYMENT TERMS. NO ACTION BY CUSTOMER ARISING UNDER SECTION 7.A ABOVE OR OTHERWISE IN CONNECTION WITH THE SALE OF THE PRODUCTS MAY BE BROUGHT MORE THAN ONE (1) YEAR AFTER THE CAUSE OF ACTION FIRST ARISES.

D. DISCLAIMER. THE EXPRESS WARRANTIES OF CHIRAL STATED IN SECTION 7.A ABOVE ARE IN LIEU OF ALL OTHER WARRANTIES, EXPRESS OR IMPLIED, INCLUDING, WITHOUT LIMITATION, THE IMPLIED WARRANTIES OF MERCHANTABILITY, FITNESS FOR A PARTICULAR PURPOSE AND NON-INFRINGEMENT OF THIRD PARTY RIGHTS. THE EXPRESS OBLIGATIONS OF CHIRAL STATED IN SECTION 7.A ABOVE ARE IN LIEU OF ANY OTHER LIABILITY OR OBLIGATION OF CHIRAL, INCLUDING, WITHOUT LIMITATION, ANY LIABILITY OR OBLIGATION FOR DAMAGE, LOSS OR INJURY (WHETHER DIRECT, INDIRECT, EXEMPLARY, SPECIAL, CONSEQUENTIAL OR INCIDENTAL) ARISING OUT OF OR IN CONNECTION WITH THE DELIVERY, USE OR PERFORMANCE OF THE PRODUCTS.

SECTION 8. LIMITATION OF LIABILITY. NOTWITHSTANDING ANYTHING TO THE CONTRARY CONTAINED IN THESE TERMS AND CONDITIONS: CHIRAL SHALL NOT BE LIABLE FOR ANY EXEMPLARY, SPECIAL, INDIRECT, CONSEQUENTIAL OR INCIDENTAL DAMAGES OF ANY KIND (INCLUDING, WITHOUT LIMITATION, LOST PROFITS), EVEN IF CHIRAL HAS BEEN ADVISED OF THE POSSIBILITY OF SUCH DAMAGES. THE FOREGOING STATES THE ENTIRE LIABILITY OF CHIRAL WITH REGARD TO THESE TERMS AND CONDITIONS AND THE PRODUCTS. THE LIMITATIONS OF LIABILITY CONTAINED IN SECTION 7 AND THIS SECTION 8 ARE A FUNDAMENTAL PART OF THE BASIS OF CHIRAL'S BARGAIN HEREUNDER, AND CHIRAL WOULD NOT SELL THE PRODUCTS ABSENT SUCH LIMITATIONS.

SECTION 9. GENERAL.

A. ENTIRE AGREEMENT. These Terms and Conditions constitute the final, complete and exclusive agreement between the Parties relating to the subject matter hereof, and supersede all prior or contemporaneous proposals, understandings, representations, warranties, promises and other communications, whether oral or written, relating to such subject matter (including, without limitation, any prior "Standard Terms and Conditions" published by CHIRAL). Except for agreements of the Parties set forth in writing and signed by an authorized representative of CHIRAL relating to the type, quantity, quality/specifications, delivery, forecasting schedule and pricing of any Product, any term or condition in any purchase order, confirmation or other document furnished by CUSTOMER at any time which is in any way inconsistent with or in addition to the terms and conditions set forth herein is hereby expressly rejected, and CHIRAL's acceptance of any purchase order of CUSTOMER is expressly made in reliance on CUSTOMER'S assent to all terms and conditions hereof. No deviation from these Terms and Conditions shall be valid unless confirmed in writing by an authorized representative of CHIRAL.

B. GOVERNING LAW. These Terms and Conditions shall for all purposes be governed by and interpreted in accordance with the laws of the State of Pennsylvania without regard to any choice of law provision that would result in the application of the laws of any jurisdiction other than the internal laws of the State of Pennsylvania to these Terms and Conditions. The Parties expressly exclude application of the United Nations Convention on Contracts for the International Sale of Goods.

C. ARBITRATION. If a dispute arises related to the purchase and sale of the Products and the Parties have not resolved such dispute through negotiation, the Parties agree to submit the dispute to arbitration. Any arbitration proceeding relating to the Agreement shall be presided over by one arbitrator who shall be agreed to by the Parties, provided that if the Parties are unable to agree on an arbitrator, then each Party shall name one arbitrator and the two arbitrators will together designate a third arbitrator, and the three arbitrators so chosen shall preside over the arbitration proceeding. The arbitration shall be held in Pennsylvania in accordance with the rules of the American Arbitration Association. Arbitration proceedings shall be conducted in the English language. Each Party agrees that the final determination/decision of the arbitrators presiding over the proceeding shall be binding on it. Notwithstanding the foregoing, the Parties may apply to any court of competent jurisdiction for preliminary or interim equitable relief, without breach of this arbitration provision. The prevailing Party in any dispute related hereto, whether in a court of law or in arbitration, shall have its reasonable costs and expenses related to such dispute reimbursed by the non-prevailing Party.

D. SEVERABILITY. If any provision of these Terms and Conditions is held by a court of competent jurisdiction to be unenforceable for any reason, the remaining provisions hereof shall be unaffected and remain in full force and effect.

E. MODIFICATIONS. Neither Party may modify, amend, supplement or otherwise change these Terms and Conditions without the prior written consent of the other Party. Any such future modification, amendment, supplement or other change (a "Change") shall apply only with respect to orders accepted after the effective date of such Change. All waivers must be in writing.

F. ASSIGNMENTS. No right of either Party under these Terms and Conditions shall be assigned or otherwise transferred without the prior express written consent of the other Party, and any attempt to assign or otherwise transfer any rights hereunder, without such consent, shall be void. Subject to the preceding sentence, these Terms and Conditions shall bind the Parties hereto and their permitted successors and assigns.

G. MISCELLANEOUS. These Terms and Conditions are not intended to provide any rights or remedies to any person or entity other than CHIRAL and CUSTOMER and their respective permitted successors and assigns (if any).

H. FORCE MAJEURE. CHIRAL shall not be responsible for any failure to fulfill its obligations hereunder due to causes beyond its reasonable control, including, without limitation, as a result of fire, explosion, earthquake, storm, flood or other weather, unavailability of necessary utilities or raw materials, strike, lockout, unavailability of components, activities of a combination of workmen or other labor difficulties, war, insurrection, riot, act of God or the public enemy, law, act, order, omission, export control regulation, proclamation, decree, regulation, ordinance, or instructions of Government or other public authorities, or judgment or decree of a court of competent jurisdiction. If any such contingency occurs, CHIRAL may elect to either (a) suspend its obligations for the duration of the delaying cause, or (b) extend the time period to complete its obligations by the length of time the contingency endures. In the event of CHIRAL's inability to supply any or all of the Products due to any of the above circumstances, CHIRAL will have the right to allocate its available supply among its CUSTOMERS, or any of them, as CHIRAL, in its sole discretion, elects without liability to CUSTOMER for any failure of performance that may result therefrom. To the extent that no allocation is made to CUSTOMER, either CUSTOMER or CHIRAL will have the right to terminate any affected purchase orders by prompt written notice to the other.

I. CONSTRUCTION AND SURVIVAL. Notwithstanding anything to the contrary contained in herein, these Terms and Conditions shall survive the purchase and sale of the Products hereunder.

DAICEL

Chiral Technologies

Chiral Technologies, Inc.

1475 Dunwoody Drive, Suite 310

West Chester, PA 19380

T +1-610-594-2100

F +1-610-594-2325

E chiral@cti.daicel.com

www.chiraltech.com

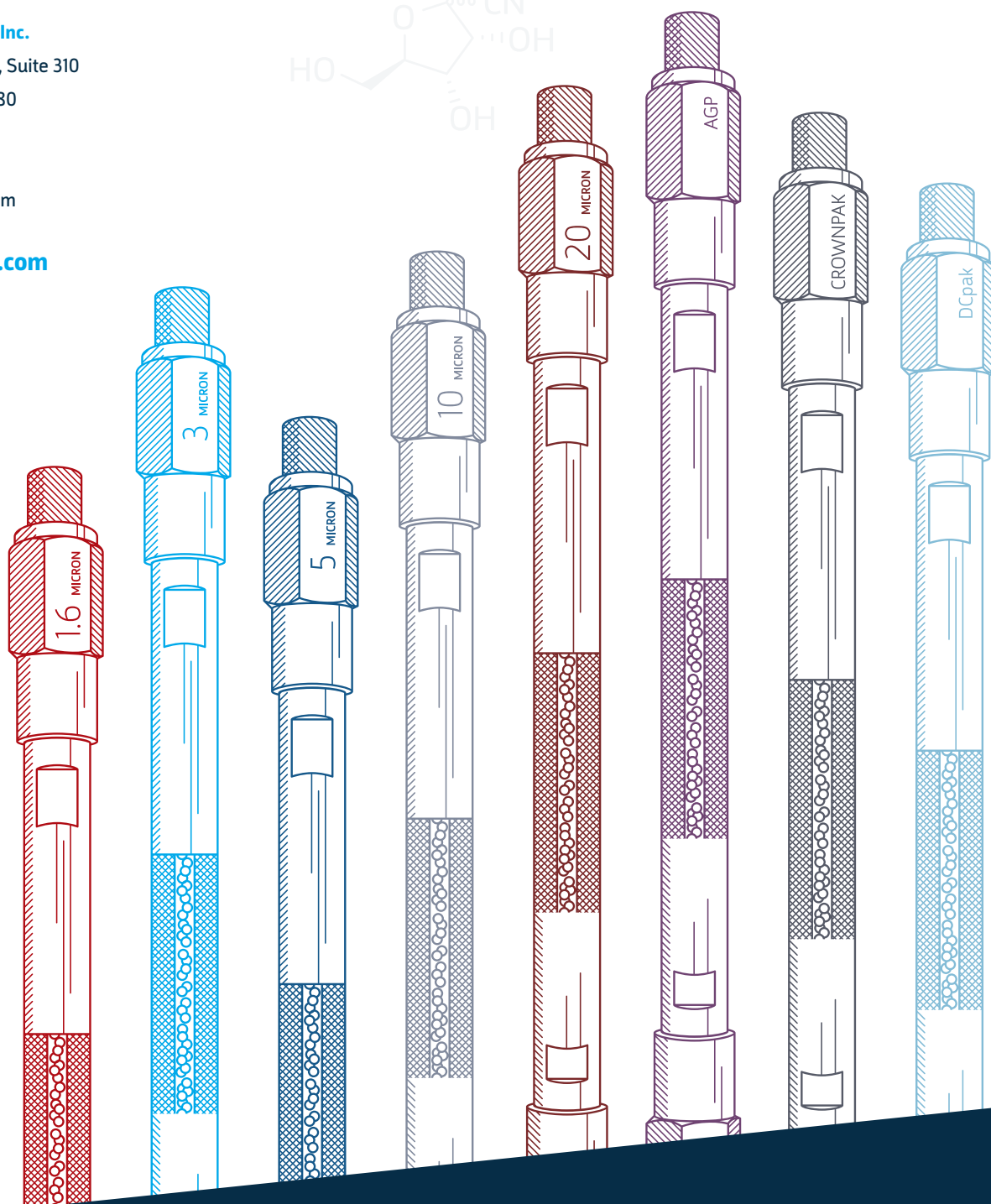
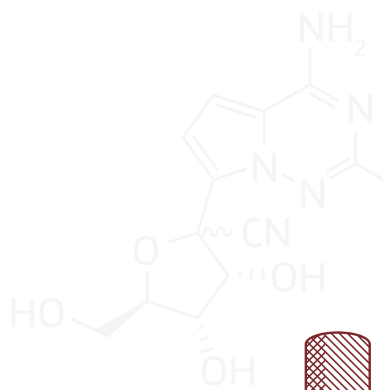

CHIRALPAK, CHIRALCEL, CROWNPAK and DCpak are registered trademarks of DAICEL CORPORATION.

© 2024 Daicel Chiral Technologies